

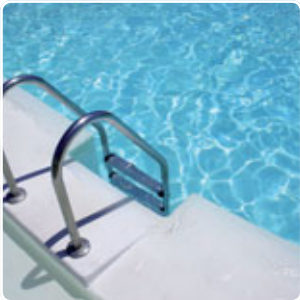

El único Ultra Range de Q-railing: resiste mas todavía.



El acero inoxidable es llamativo, y debe mantenerse así, también en sitios donde se puede oxidar. Por eso, Q-railing, como empresa líder en el mercado de barandillas, ofrece productos de inimitable calidad. Nuestro Ultra Range es único en su tipo: gracias a su alta resistencia a la corrosión, esta gama de productos es la más adecuada para su uso en piscinas y zonas costeras. Todo esto, por supuesto, con dos años de garantía.

* Garantía anti-corrosión de dos años sujeto a términos y condiciones.





Pared - tubo

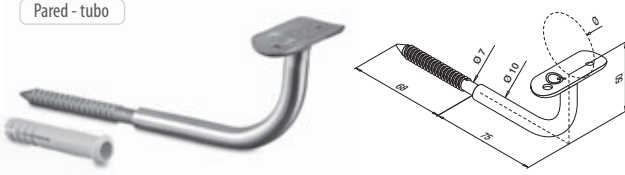

MOD: 0110

2205							
OUTDOOR	Ø					€/ pz.	
18.0110.042.12	42,4	QS-97 p45		2		18,30	

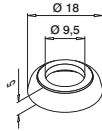

MOD: 0509

2205							
OUTDOOR						€/ pz.	
18.0509.012.12				2		2,05	



Tubo - tubo

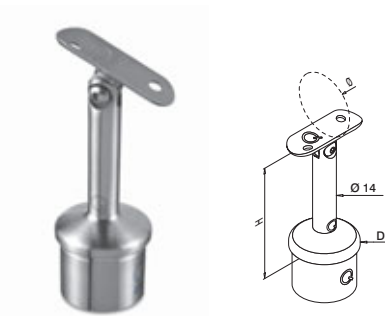

MOD: 0698 - D 42,4 mm

2205							
OUTDOOR	H	Ø	D			€/ pz.	
18.0698.242.12	80	42,4	42,4 x 2,0	QS-97 p45	2	19,65	



0-70°

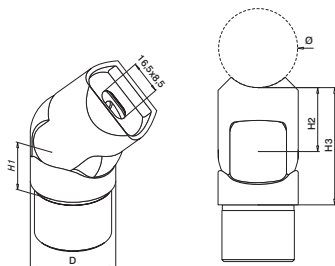

MOD: 0776 - D 42,4 mm

2205							
OUTDOOR	Ø	D		H1	H2	H3	€/ pz.
18.0776.242.12	42,4	Ø 42,4 x 2,0	QS-96 p45	29	35	62	40,45



Pared - tubo

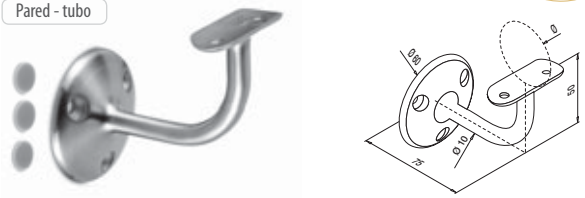

MOD: 0116

2205							
OUTDOOR	Ø					€/ pz.	
18.0116.042.12	42,4	QS-97 p45 / QS-99 p45		2		14,90	



Tubo - tubo



MOD: 0690 - D 42,4 mm

2205							
OUTDOOR	H	Ø	D			€/ pz.	
18.0690.242.12	80	42,4	42,4 x 2,0	QS-97 p45	2	19,65	

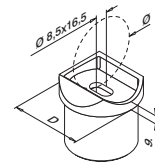

MOD: 0772 - D 42,4 mm

2205							
OUTDOOR	Ø	D				€/ pz.	
18.0772.242.12	42,4	Ø 42,4 x 2,0	QS-96 p45		2	12,15	



Q-INFO MOD: 0110 / 0509

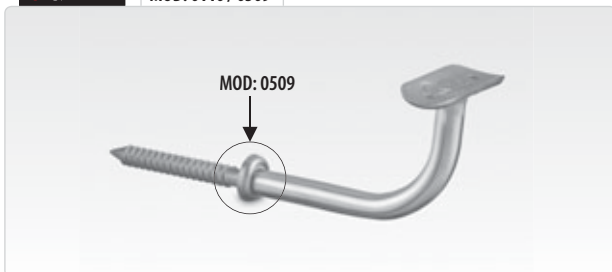

Q-INFO MOD: 0772

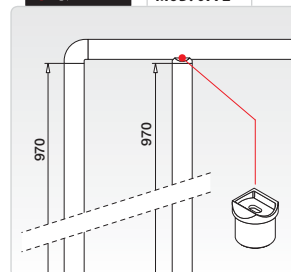

Q-INFO MOD: 0776

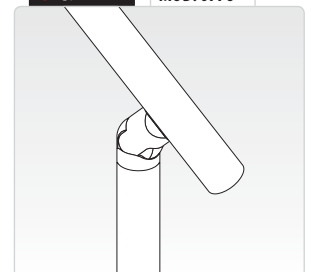

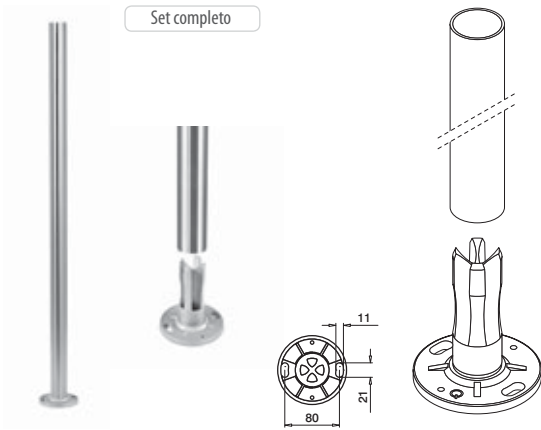

Set completo

MOD: 0950

2205

OUTDOOR	Ø	H	Q5-500 p46	1	€/ pz.
18.0950.242.12	42,4 x 2,0	970			79,70

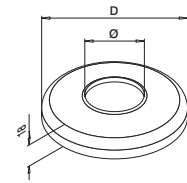

MOD: 0510

2205

OUTDOOR	Ø	D	2	€/ pz.
18.0510.042.12	42,4	Ø 105		11,25

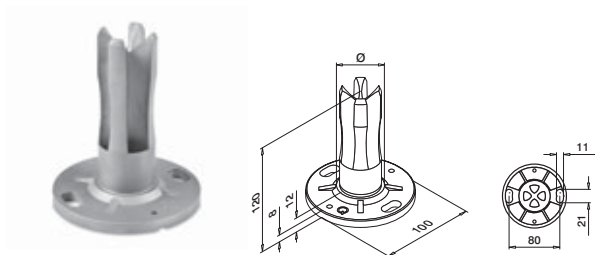

MOD: 0942

2205

OUTDOOR	Ø	Q5-500 p46	2	€/ pz.
18.0942.242.00	42,4 x 2,0			44,75



MOD: 3901

2205

OUTDOOR	Ø	1	€/ pz.
18.3901.242.12	42,4 x 2,0		34,95



Q-INFO **MOD: 0942**

Q-21
Q-Glue
50 ml
19.1331.000.00

MOD: 0950

Q-INFO **MOD: 0510**

1,5mm

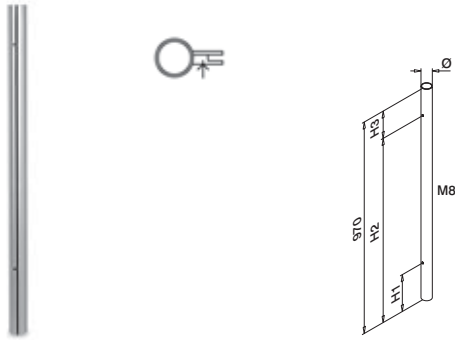

MOD: 0927

2205		Ø	H1	H2	H3		€/ pz.
18.0927.242.12	OUTDOOR	42,4 x 2,0	175	850	120	1	45,75

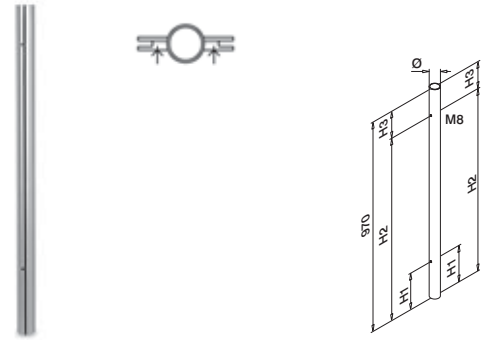

MOD: 0928

2205		Ø	H1	H2	H3		€/ pz.
18.0928.242.12	OUTDOOR	42,4 x 2,0	175	850	120	1	45,75

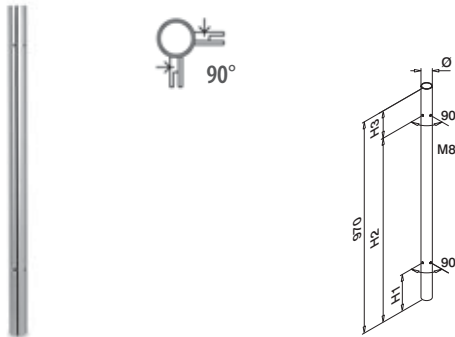

MOD: 0929

2205		Ø	H1	H2	H3		€/ pz.
18.0929.242.12	OUTDOOR	42,4 x 2,0	175	850	120	1	45,75



DISCOUNT Q-TUBE

Ver la página 197

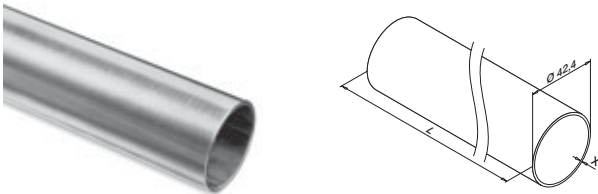

Ø 42,4 mm

2205		X (mm)	L	€/ M	€/ pz.
18.0900.242.12	OUTDOOR	2,0	5000 mm	32,65	163,25
18.8925.242.12		2,0	2500 mm	32,65	81,65



Q-INFO MOD: 0900 / 8925

Q-CALCULATIONS

Ø	A (mm ²)	Ix=ly (cm ⁴)	Wy (cm ³)	ω (kg/m)	σ 0,2 (N/mm ²)
Tubo 42,4 x 2,0	2,53	5,19	2,44	1,98	460

Válido para material 2205 y diferentes longitudes

Q-INFO

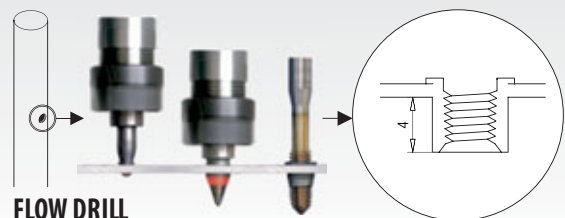

FLOW DRILL

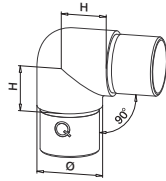

MOD: 0303 - Ø 42,4 mm

2205

OUTDOOR	H	Ø	📦	€/ pz.
18.0303.242.12	30	42,4 x 2,0	2	23,10



0 - 70°

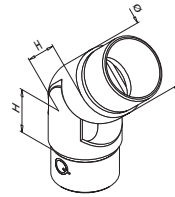

MOD: 0312 - Ø 42,4 mm

2205

OUTDOOR	H	Ø	📦	€/ pz.
18.0312.242.12	27	42,4 x 2,0	2	37,70

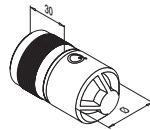

MOD: 5792 - Ø 42,4 mm

2205

OUTDOOR	H	Ø	📦	€/ pz.
18.5792.242.00	27	38,3	2	13,10

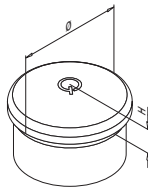

MOD: 0730 - Ø 42,4 mm

2205

OUTDOOR	Ø	H	📦	€/ pz.
18.0730.242.12	42,4 x 2,0	10	2	6,50



Q-INFO



Ahorre tiempo y dinero con Q-tube

Q-tubo cuenta con una tolerancia mucho más baja que un tubo comercial estándar. Incluso se ha adaptado la junta de soldadura de Q-tubo especialmente a nuestros accesorios. Por tanto, el tubo se adapta perfectamente a nuestros accesorios para que usted pueda trabajar de forma rápida y efectiva. Para evitar daños, y garantizar así la calidad, cada sección del tubo se empaqueta por separado.

Q-INFO

MOD: 5792

Q-INFO

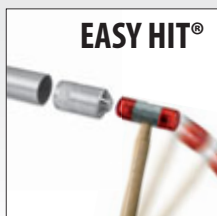

Q-21
Q-Glue
50 ml
19.1331.000.00



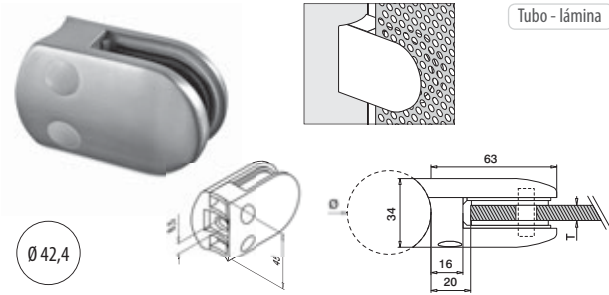

Tubo - lámina

Ø 42,4

MOD: 2802

2205		Ø	T (mm)			€/ pz.
OUTDOOR						
18.2802.042.12		42,4	2	QS-96 p45, 63	4	15,75

MOD: 2803

2205		Ø	T (mm)			€/ pz.
OUTDOOR						
18.2803.042.12		42,4	3	QS-96 p45, 63	4	15,75

MOD: 2804

2205		Ø	T (mm)			€/ pz.
OUTDOOR						
18.2804.042.12		42,4	4	QS-96 p45, 63	4	15,75

NEW



ORDER P.43

Accesorios adaptadores para láminas



Gomas para pinzas para todos los modelos adaptadores para láminas (2 unidades por pinza)

MOD: 50

MOD:	T (mm)		€/ pz.
19.5001.002.00	2802	8	0,40
19.5001.003.00	2803	8	0,40
19.5001.004.00	2804	8	0,40

NEW

Q-INFO



Q-23
Q-cleaner
400 ml
19.0601.000.00



Q-22
Q-ultra-clean
500 ml
19.0610.000.00



Tubo - vidrio

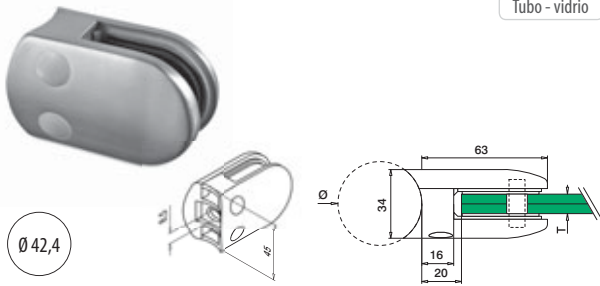

MOD: 28

2205



OUTDOOR	Ø	T (mm)			€/ pz.
18.2806.042.12	42,4	6	QS-96 p45, 63	4	15,75
18.2808.042.12	42,4	8	QS-96 p45, 63	4	15,75
18.2810.042.12	42,4	10	QS-96 p45, 63	4	15,75

2205



OUTDOOR	Ø	T (mm)			€/ pz.
18.2807.042.12	42,4	6,76 (3 - 0,76 - 3)	QS-96 p45, 63	4	15,75
18.2809.042.12	42,4	8,76 (4 - 0,76 - 4)	QS-96 p45, 63	4	15,75
18.2841.042.12	42,4	8,38 (4 - 0,38 - 4)	QS-96 p45, 63	4	15,75
18.2844.042.12	42,4	9,52 (4 - 1,52 - 4)	QS-96 p45, 63	4	15,75



Accesorios

Accesorios pinzas para vidrio



Gomas para pinzas para todos los modelos de pinzas para vidrio

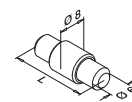

Pasadores de seguridad para pinzas para vidrio

MOD: 50

	MOD:	T (mm)	Unidades por pinza		€/ pz.
19.5001.006.00	28	6	2	8	0,40
19.5001.007.00	28	6,76 (3 - 0,76 - 3)	2	8	0,40
19.5001.008.00	28	8	2	8	0,40
19.5001.009.00	28	8,76 (4 - 0,76 - 4)	2	8	0,40
19.5001.010.00	28	10	2	8	0,40
19.5001.041.00	28	8,38 (4 - 0,38 - 4)	2	8	0,40
19.5001.044.00	28	9,52 (4 - 1,52 - 4)	2	8	0,40



MOD: 5015

IN-/OUTDOOR	Para modelo	L (mm)		€/ pz.
19.5015.022.18	MOD: 28	22	4	1,75



Q-INFO

MOD: 5015

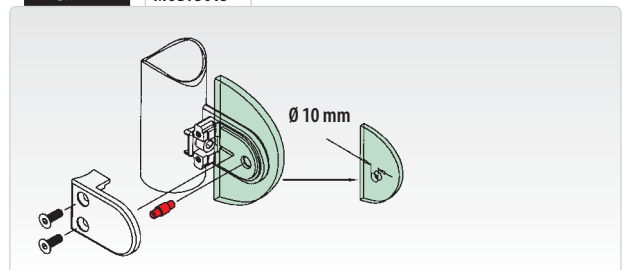



Tapones de nilón para Mod: 0116
(3 piezas necesarias)

MOD: 5017

Color		€/ pz.
19.5017.000.19 Apariencia de acero inoxidable	6	0,15

NEW

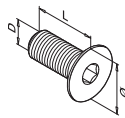

Tornillo avellanado con hexágono interior allen

MOD: 0670 - DIN7991

Para modelos 28 en 2205

1.4529		QS	Q	Ø	D	L (mm)		€/ 50 pzs.
OUTDOOR	QS	Q	Ø	D	L (mm)		€/ 50 pzs.	
95.0670.616.18	05-95	Q-4	12	M6	16	50	57,50	

NEW

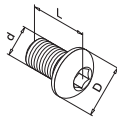

MOD: 0511 - ISO7380

1.4529		QS	Q	d	D	L (mm)		€/ 50 pzs.
OUTDOOR	QS	Q	d	D	L (mm)		€/ 50 pzs.	
95.0511.510.18	05-501	Q-3	M5	9,5	10	50	47,50	
95.0511.516.18	05-97	Q-3	M5	9,5	16	50	52,50	

NEW

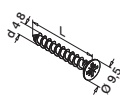

MOD: 0220 - DIN7982

1.4529		QS	Q	L (mm)		€/ 50 pzs.
OUTDOOR	QS	Q	L (mm)		€/ 50 pzs.	
93.0220.538.18	05-99	-	38	50	47,50	
93.0220.560.18	05-502	-	60	50	67,50	

NEW



Tapones de nilón para tornillos laterales
(2 unidades por cada pinza para vidrio)

MOD: 5010

Color		€/ pz.
19.5010.060.19 Apariencia de acero inoxidable	8	0,15

NEW

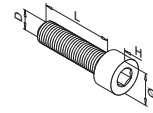

MOD: 0680 - DIN912

1.4529		QS	Q	Ø	H	D	L (mm)		€/ 50 pzs.
OUTDOOR	QS	Q	Ø	H	D	L (mm)		€/ 50 pzs.	
95.0680.820.18	05-96	Q-6	13	8	M8	20	50	80,00	

NEW

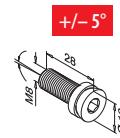

$\pm 5^\circ$ Tornillo ajustable

MOD: 0900

Para todos los modelos en 2205

1.4529		QS	Q	Ø	D		€/ 50 pzs.
OUTDOOR	QS	Q	Ø	D		€/ 50 pzs.	
95.0900.820.18	05-98	Q-5	13	M8	50	140,00	

NEW

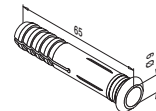

MOD: 0841

QS		€/100 pzs.
93.0841.965.36	05-506	20,00

NEW



MOD: 4010 - FHB

1.4529						
OUTDOOR	QS	M	L (mm)		€/ pz.	
19.4010.010.18	05-500	M10	60	10	51,10	

NEW



Caja de herramientas de 25 piezas y de acero inoxidable. Contiene: 6 destornilladores, 9 brocas, 9 destornilladores acodados

MOD: 0720

	Q	Q(○)						€/ pz.
19.0720.000.14	0-70	0-1,5	0-2	0-2,5	0-3		1	187,05
		0-4	0-5	0-6	0-8	0-10		

NEW

Q-INFO

Manual fischer Highbond-Anker FHB

FHB

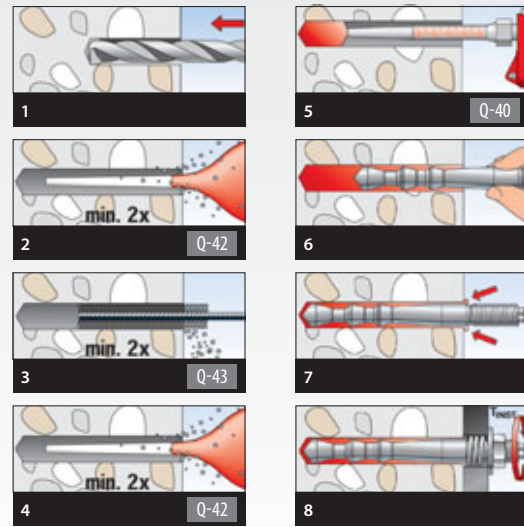

fischer Partner Q-railing®